



Access Control & Egress Planning

—

Altaf A. Afridi, PMP, LEED AP, FDAI

Dec 2014



“Safety Design in Buildings” is a Registered Provider with **The American Institute of Architects Continuing Education Systems (AIA/CES)**. Credit(s) earned on completion of this program will be reported to **AIA/CES** for AIA members. Certificates of Completion for both AIA members and non-AIA members are available upon request.

This program is registered with **AIA/CES** for continuing professional education. As such, it does not include content that may be deemed or construed to be an approval or endorsement by the AIA of any material of construction or any method or manner of handling, using, distributing, or dealing in any material or product.

Questions related to specific materials, methods, and services will be addressed at the conclusion of this presentation.

Copyright Materials

This presentation is protected by US and International Copyright laws. Reproduction, distribution, display and use of the presentation without written permission of the speaker is prohibited.

© DORMA Gulf Door Controls FZE 2014



Learning Objectives

At the end of this program, participants will be able to:

1. Have introduction to basics of various types of Access Control components
2. Know Factors to be considered in Egress planning in case of fire or similar scenarios, where tenants have to evacuate the building (based as per NFPA 101).
3. We will also know how Access control systems and egress planning can be in conflict if not planned properly and may severely effect the safety of tenants in case of emergency.



Presentation Summary

1. What is Access Control?
2. Access Control types and how it is achieved.
3. Various components used industry uses for Access Control
4. What is Egress Planning?
5. Factors to be considered while Egress planning of various types of occupancies.
6. Single Door example, to show how Access control strategy changes with requirements.
7. Re-Entry requirement of NFPA 101 for fire exit staircases.
8. Case studies
9. Fire Door Assembly Inspector



About the Presenter

Altaf A. Afridi

Regional Marketing Director – MENA, DORMA Gulf Door Controls FZE

Altaf Afridi, Regional Marketing Director (MENA) and head of the Project Management Team, based in United Arab Emirates, a Civil Engineer having 10 years of extensive experience in Architectural hardware and openings industry of his total 17 years of experience. Specialist of fire rated doors, first certified FDAI (Fire Door Assembly Inspector) outside US, certified Project Management Professional (PMP), LEED AP and Life Safety code (NFPA 101) specialist.

While working with architects Mr. Afridi has learnt NFPA 101 Life Safety Code, NFPA 80 Standard for fire doors from them while providing related solutions and thus gained a good data base of lessons learnt. He has been doing presentations on Life Safety code at architect offices in UAE, Saudi Arabia, Jordan, Lebanon and Qatar. He has been assisting architects providing solutions at the design stage for doors, doors hardware, movable walls, glass fittings and access control products.

SDiB - Safety Design in Buildings

Access Control & Egress Planning.

Access Control.

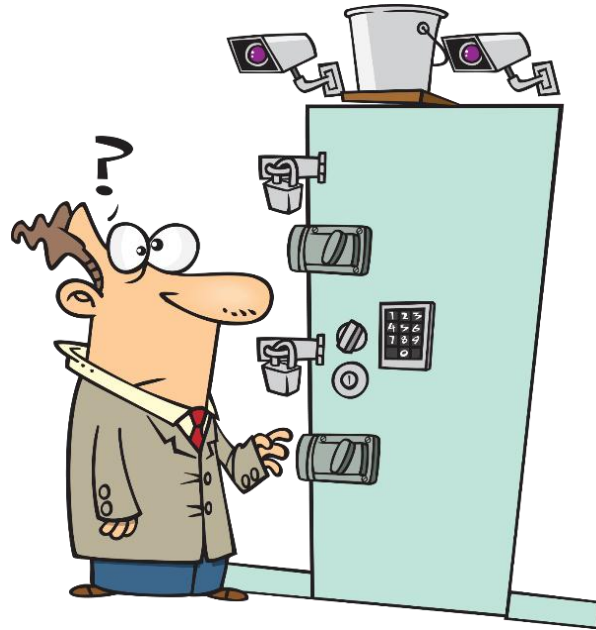

The practice of **restricting ENTRANCE** to a property, a building, or a room **to** authorized persons for the sake of security.

SDiB - Safety Design in Buildings

Access Control & Egress Planning.

How Access Control is achieved?

Conventional/Mechanical Access Control



Electronic Access Control



SDiB - Safety Design in Buildings

Access Control & Egress Planning.

How Access Control is achieved?

Conventional/Mechanical Access Control



Electronic Access Control



SDiB - Safety Design in Buildings

Access Control & Egress Planning.

How Access Control is achieved?

Conventional/Mechanical Access Control



Electronic Access Control

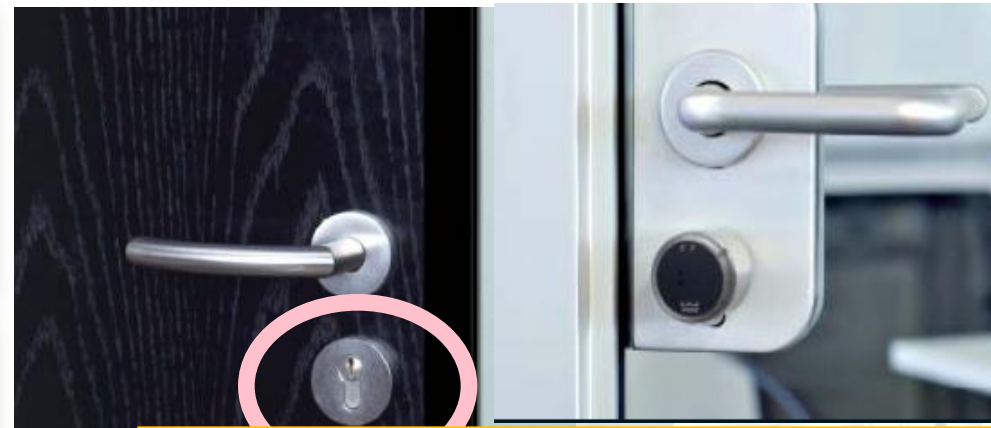

Online access control systems without cabling at the door:
XS fitting online with radio connection to the XS traffic point



SDiB - Safety Design in Buildings

Access Control & Egress Planning.

How Access Control is achieved?

Conventional/Mechanical Access Control



EN

Cylinders



EN

Padlocks



EN

Multipoint locking



ANSI

Mortise Lock SFIC core available.



EN

Mortise Locks



ANSI

Cylindrical Lock



ANSI



ANSI



Electronic Access Control

Secured access to the underground car park:
can be simply achieved by the DORMA access control system



SDiB - Safety Design in Buildings

Access Control & Egress Planning.

How Access Control is achieved?

Conventional/Mechanical Access Control



Electronic Access Control



SDiB - Safety Design in Buildings

Access Control & Egress Planning.

How Access Control is achieved?

Conventional/Mechanical Access Control



Electronic Access Control



SDiB - Safety Design in Buildings

Access Control & Egress Planning.

How Access Control is achieved?

Conventional/Mechanical Access Control



EN

Cylinders



EN

Padlocks



EN

Multipoint locking



ANSI

Mortise Lock SFIC core available.



EN

Mortise Locks



ANSI

Cylindrical Lock



ANSI



ANSI



Electronic Access Control



SDiB - Safety Design in Buildings

Access Control & Egress Planning.

How Access Control is achieved?

Conventional/Mechanical Access Control



EN

Cylinders



EN

Padlocks



EN

Multipoint locking



ANSI

Mortise Lock SFIC core available.



EN

Mortise Locks



ANSI

Cylindrical Lock



ANSI



ANSI



Electronic Access Control



SDiB - Safety Design in Buildings

Access Control & Egress Planning.

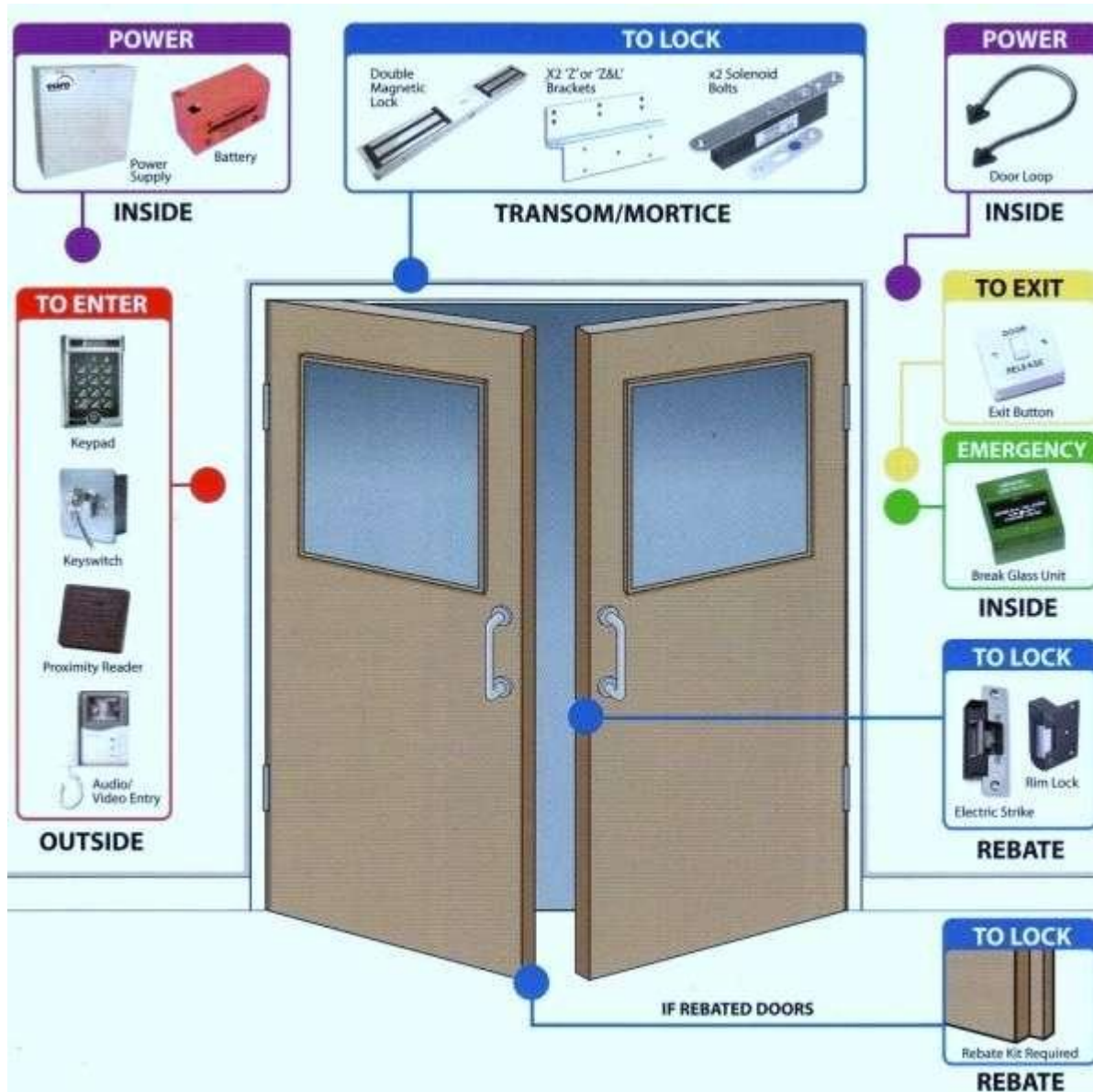

SDiB - Safety Design in Buildings

Access Control & Egress Planning.

How Access Control is achieved?

Conventional/Mechanical Access Control



Electronic Access Control



How Access Control is achieved?

Conventional/Mechanical Access Control

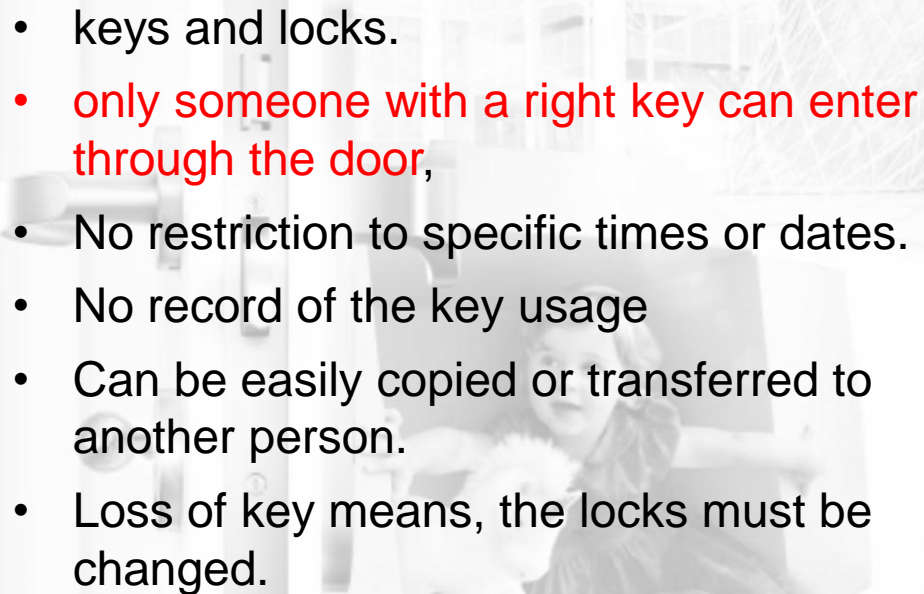
- keys and locks.
 - **only someone with a right key can enter through the door,**
 - No restriction to specific times or dates.
 - No record of the key usage
 - Can be easily copied or transferred to another person.
 - Loss of key means, the locks must be changed.
- 
- A grayscale photograph of a young child sitting on a white chair in a room. The child is looking towards the camera. In the background, a door is visible, illustrating the concept of conventional mechanical access control.

Electronic Access Control

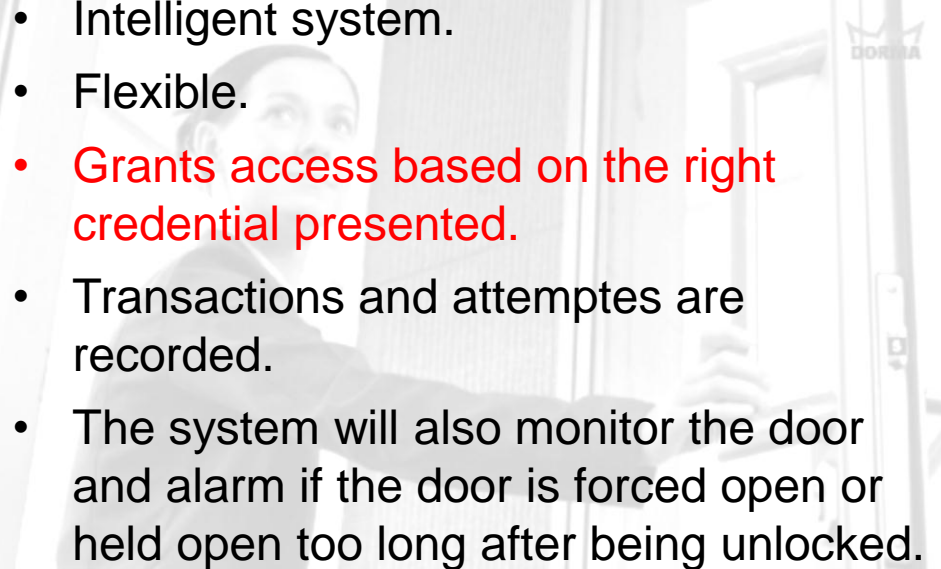
- Intelligent system.
 - Flexible.
 - **Grants access based on the right credential presented.**
 - Transactions and attempts are recorded.
 - The system will also monitor the door and alarm if the door is forced open or held open too long after being unlocked.
- 
- A grayscale photograph of a woman in a dark jacket using a handheld device to interact with an electronic door lock. The lock is mounted on a door, and the woman is looking at the device. This illustrates electronic access control.

SDiB - Safety Design in Buildings

Access Control & Egress Planning.

What is Egress Planning?

- In the **event of fire** or other emergency, occupants must be able **to vacate a building or space** quickly.
- Architects incorporate certain elements into their building design that provide a **protected path of travel** from any point inside the building to a **safe place outside or inside** the building.



SDiB - Safety Design in Buildings

Access Control & Egress Planning.



SDiB - Safety Design in Buildings

Access Control & Egress Planning.

- Codes and standards establish the minimum criteria for meeting certain levels of Safety in Buildings.



BS 5306-8:2000



ANSI/BHMA
A156.18
American National
Standard for Materials
and Finishes

COMPLETE OUR SHORT
SURVEY AND DOWNLOAD
THE PDF — FREE!



متطلبات الوقاية
للحماية من الحريق في المباني
الطبعة الثانية ٢٠٠٣م
الإصدار الثاني

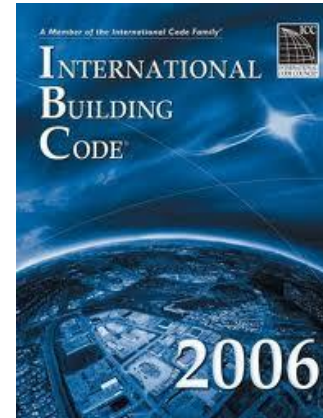
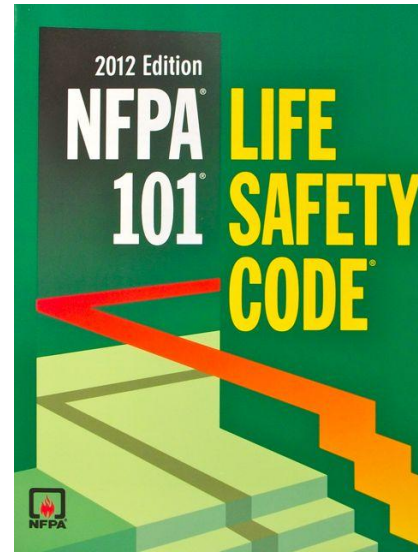
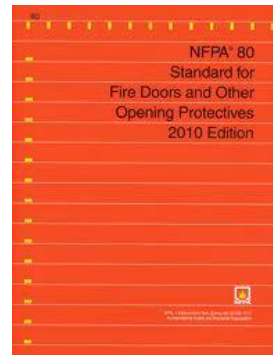

SDiB - Safety Design in Buildings

Access Control & Egress Planning.

Classification of Occupancies for Egress planning

6.1.2 Assembly.

For requirements, see Chapters 12 and 13.

6.1.2.1* Definition — Assembly Occupancy. An occupancy (1) used for a gathering of 50 or more persons for deliberation, worship, entertainment, eating, drinking, amusement, awaiting transportation, or similar uses; or (2) used as a special amusement building, regardless of occupant load.

A.6.1.2.1 Assembly Occupancy. Assembly occupancies might include the following:

- (1) Armories
- (2) Assembly halls
- (3) Auditoriums
- (4) Bowling lanes
- (5) Club rooms
- (6) College and university classrooms, 50 persons and over
- (7) Conference rooms
- (8) Courtrooms
- (9) Dance halls
- (10) Drinking establishments
- (11) Exhibition halls
- (12) Gymnasiums
- (13) Libraries
- (14) Mortuary chapels
- (15) Motion picture theaters
- (16) Museums
- (17) Passenger stations and terminals of air, surface, underground, and marine public transportation facilities
- (18) Places of religious worship
- (19) Pool rooms

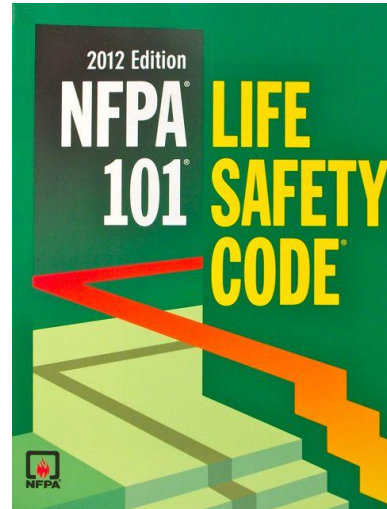

- (20) Recreation piers
- (21) Restaurants
- (22) Skating rinks
- (23) Special amusement buildings, regardless of occupant load
- (24) Theaters

SDiB - Safety Design in Buildings

Access Control & Egress Planning.

Classification of Occupancies for Egress planning

6.1.3 Educational.

For requirements, see Chapters 14 and 15.

6.1.3.1* Definition — Educational Occupancy. An occupancy used for educational purposes through the twelfth grade by six or more persons for 4 or more hours per day or more than 12 hours per week.

A.6.1.3.1 Educational Occupancy. Educational occupancies include the following:

- (1) Academies
- (2) Kindergartens
- (3) Schools

Educational occupancies are limited to facilities used for educational purposes through the twelfth grade. A college classroom does not meet this criterion and is classified as a business occupancy or, where the college classroom has an occupant load of 50 or more, as an assembly occupancy.

14.2.4 Number of Means of Egress.

14.2.4.1 The number of means of egress shall be in accordance with [Section 7.4](#).

14.2.4.2 Not less than two separate exits shall be in accordance with the following criteria:

- (1) They shall be provided on every story.
- (2) They shall be accessible from every part of every story and mezzanine; however, exit access travel shall be permitted to be common for the distance permitted as common path of travel by [14.2.5.3](#).



Fire in Villagio Mall , Qatar – in May 2012 (19 killed – 13 were nursery kids)

Horror as toddlers are left trapped in first floor nursery after staircase collapses

Firefighters forced to break through roof to evacuate victims

Relative of one two-year-old victim said building did not appear to have fire alarms or sprinklers



DOHA: A fire at a nursery in a main shopping center in the Qatari capital killed 19 people including 13 children

6.1.5 Health Care.

For requirements, see Chapters 18 and 19.

6.1.5.1* Definition — Health Care Occupancy. An occupancy used to provide medical or other treatment or care simultaneously to four or more patients on an inpatient basis, where such patients are mostly incapable of self-preservation due to age, physical or mental disability, or because of security measures not under the occupants' control.

A.6.1.5.1 Health Care Occupancy. Health care occupancies include the following:

- (1) Hospitals
- (2) Limited care facilities
- (3) Nursing homes



18.3.7* Subdivision of Building Spaces.

18.3.7.1 Buildings containing health care facilities shall be subdivided by smoke barriers (*see 18.2.4.3*), unless otherwise permitted by 18.3.7.2, as follows:

- (1) To divide every story used by inpatients for sleeping or treatment into not less than two smoke compartments
- (2) To divide every story having an occupant load of 50 or more persons, regardless of use, into not less than two smoke compartments
- (3) To limit the size of each smoke compartment required by 18.3.7.1(1) and (2) to an area not exceeding 22,500 ft² (2100 m²), unless the area is an atrium separated in accordance with 8.6.7, in which case no limitation in size is required
- (4) To limit the travel distance from any point to reach a door in the required smoke barrier to a distance not exceeding 200 ft (61 m)



Smoke/Fire compartmentation.

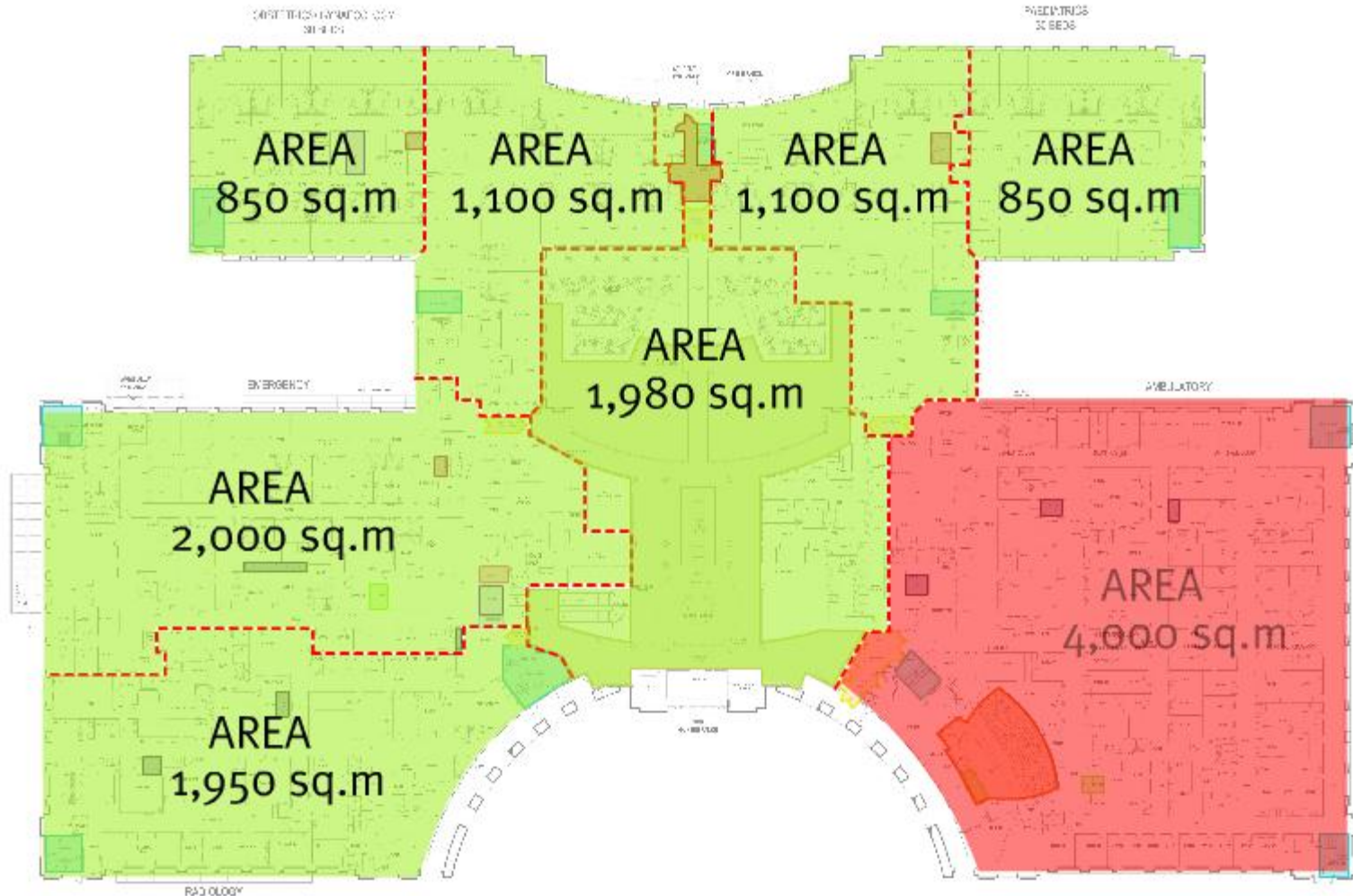

Smoke/Fire compartmentation.

A.18.3.7.6 Smoke barrier doors are intended to provide access to adjacent zones. The pair of cross-corridor doors are required to be opposite swinging. Access to both zones is required.

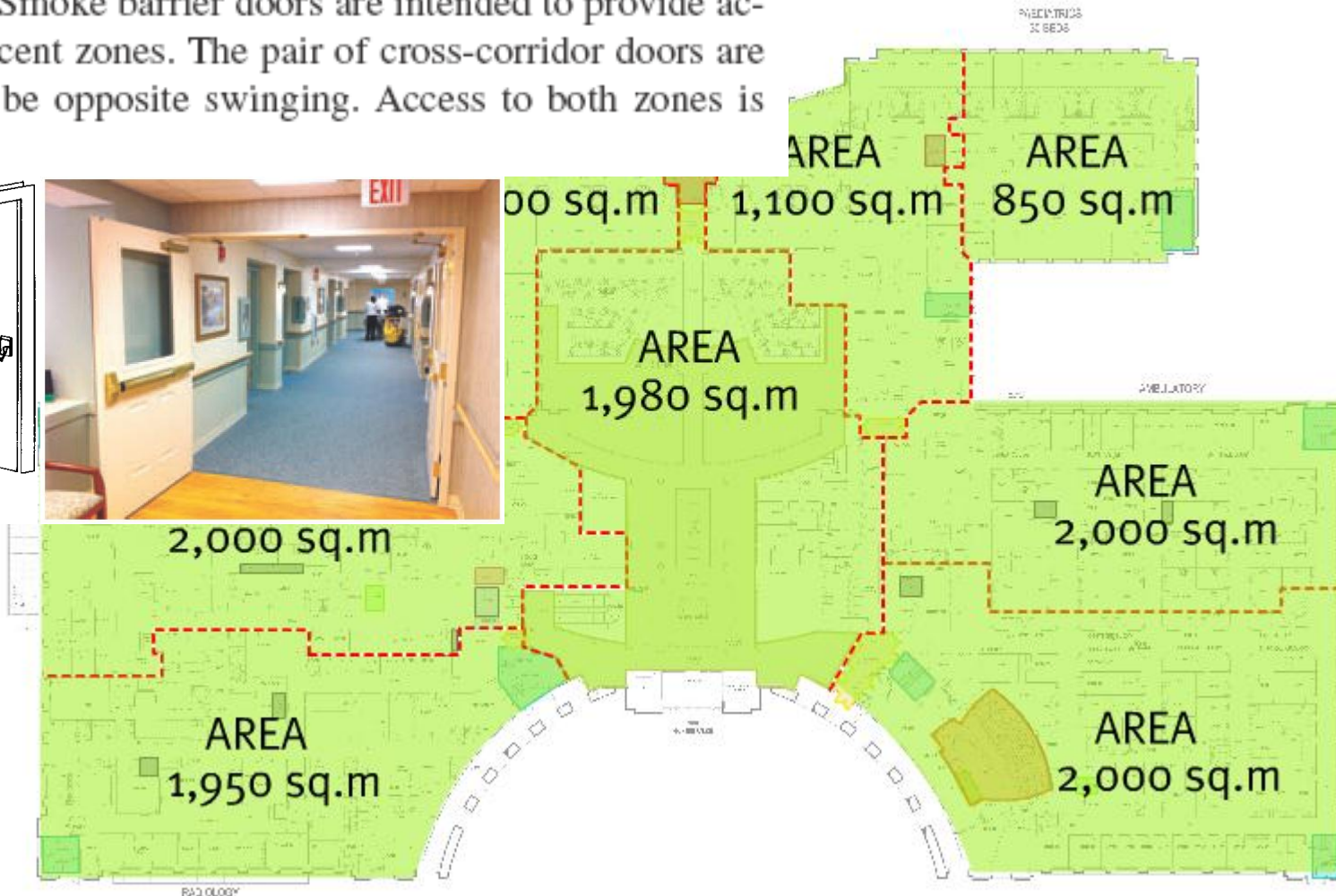
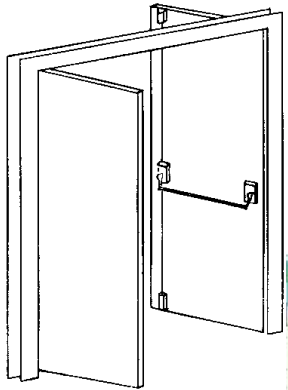

6.1.7 Detention and Correctional.

For requirements, see Chapters 22 and 23.

6.1.7.1* Definition — Detention and Correctional Occupancy. An occupancy used to house one or more persons under varied degrees of restraint or security where such occupants are mostly incapable of self-preservation because of security measures not under the occupants' control.

A.6.1.7.1 Detention and Correctional Occupancy. Detention and correctional occupancies include the following:

- (1) Adult and juvenile substance abuse centers
- (2) Adult and juvenile work camps
- (3) Adult community residential centers
- (4) Adult correctional institutions
- (5) Adult local detention facilities
- (6) Juvenile community residential centers
- (7) Juvenile detention facilities
- (8) Juvenile training schools



6.1.8 Residential.

For requirements, see Chapters 24 through 31.

6.1.8.1 Definition — Residential Occupancy. An occupancy that provides sleeping accommodations for purposes other than health care or detention and correctional.

6.1.8.1.1* Definition — One- and Two-Family Dwelling Unit. A building that contains not more than two dwelling units with independent cooking and bathroom facilities.

6.1.8.1.2 Definition — Lodging or Rooming House. A building or portion thereof that does not qualify as a one- or two-family dwelling, that provides sleeping accommodations for a total of 16 or fewer people on a transient or permanent basis, without personal care services, with or without meals, but without separate cooking facilities for individual occupants.

6.1.8.1.3* Definition — Hotel. A building or groups of buildings under the same management in which there are sleeping accommodations for more than 16 persons and primarily used by transients for lodging with or without meals.

6.1.8.1.4* Definition — Dormitory. A building or a space in a building in which group sleeping accommodations are provided for more than 16 persons who are not members of the same family in one room, or a series of closely associated rooms, under joint occupancy and single management, with or without meals, but without individual cooking facilities.

6.1.8.1.5 Definition — Apartment Building. A building or portion thereof containing three or more dwelling units with independent cooking and bathroom facilities.



6.1.10 Mercantile.

For requirements, see Chapters 36 and 37.

6.1.10.1* Definition — Mercantile Occupancy. An occupancy used for the display and sale of merchandise.

A.6.1.10.1 Mercantile Occupancy. Mercantile occupancies include the following:

- (1) Auction rooms
- (2) Department stores
- (3) Drugstores
- (4) Restaurants with fewer than 50 persons
- (5) Shopping centers
- (6) Supermarkets

Office, storage, and service facilities incidental to the sale of merchandise and located in the same building should be considered part of the mercantile occupancy classification.



6.1.11 Business.

For requirements, see Chapters 38 and 39.

6.1.11.1* Definition — Business Occupancy. An occupancy used for the transaction of business other than mercantile.

A.6.1.11.1 Business Occupancy. Business occupancies include the following:

- (1) Air traffic control towers (ATCTs)
- (2) City halls
- (3) College and university instructional buildings, classrooms under 50 persons, and instructional laboratories
- (4) Courthouses
- (5) Dentists' offices
- (6) Doctors' offices
- (7) General offices
- (8) Outpatient clinics (ambulatory)
- (9) Town halls



SDiB - Safety Design in Buildings

Access Control & Egress Planning.

Single external door

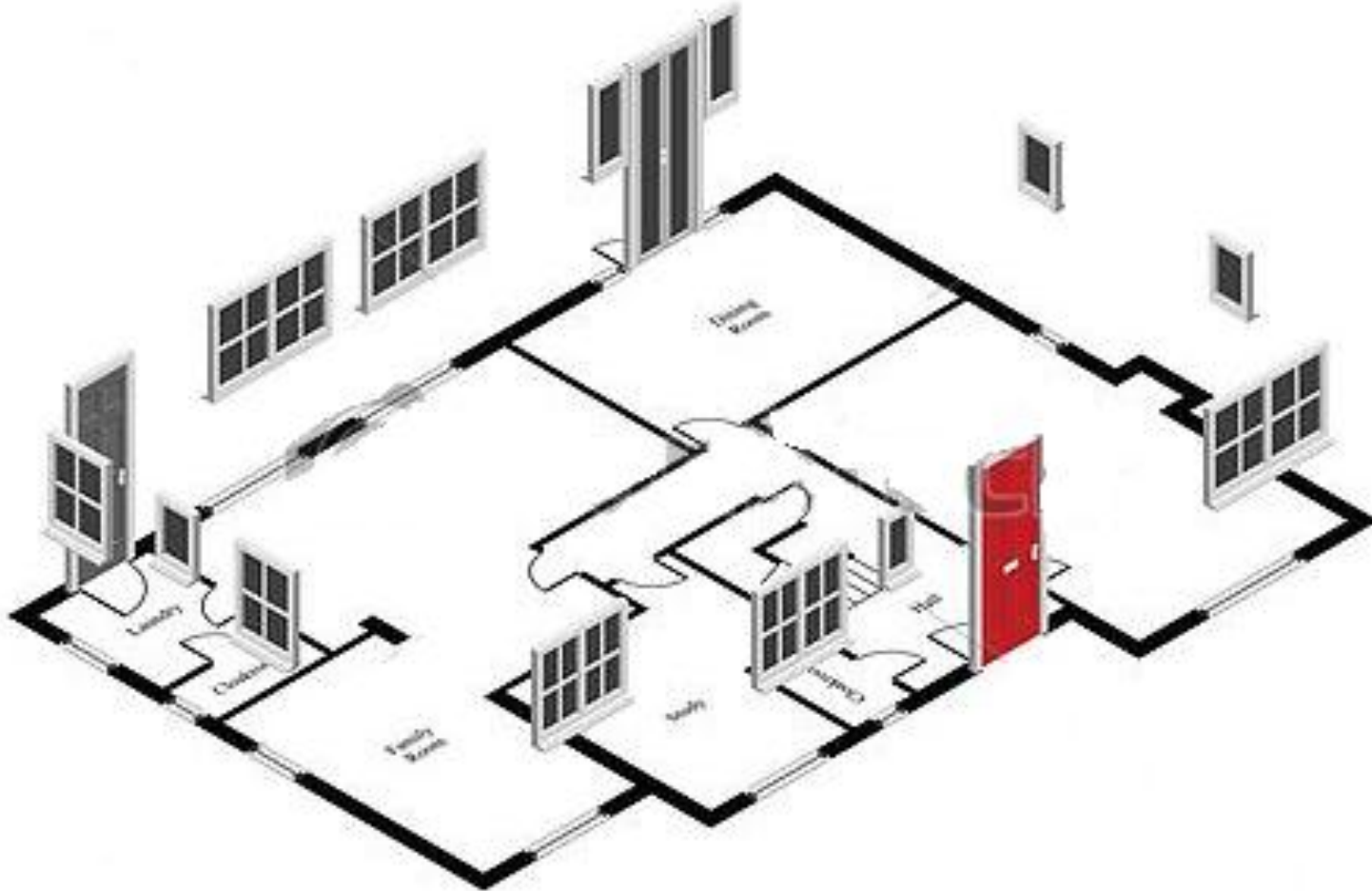

SDiB - Safety Design in Buildings

Access Control & Egress Planning.

Single external door



SAFE



SECURE



Outside

Inside

Cylinder x Cylinder*

D862

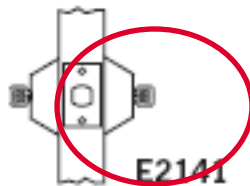

E2141

- Dead bolt operated by key either side.
- Bolt automatically deadlocks when fully thrown.

SDiB - Safety Design in Buildings

Access Control & Egress Planning.

Single external door



SAFE



SECURE



FIRE RATED



Outside

Inside

Cylinder x Turn

D860

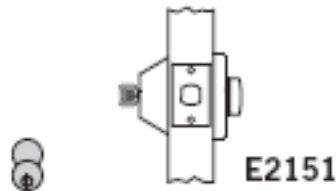

- Dead bolt operated by key outside or by turn inside.
- Bolt automatically deadlocks when fully thrown.

■ Locks and Latches – LOCK SETS

1. Fire doors to be latched.
2. Only labeled locks and latches are allowed on fire doors.
3. The Throw of the latch to be as per fire door label.

Certification/Compliance:

ANSI: Meets A156.13 Series 1000, operational and security Grade 1. Meets A117.1 accessibility code and ADA requirements for barrier-free accessibility.

UL/CUL – UL 10C Positive Pressure: All M9000 are listed 3 hour fire rated. Locks are listed for A label and lessor class doors, 4'0" x 8'0" maximum per leaf.

California State Reference Code: (formerly title 19, California State Fire Marshall standard) All levers with returns, return to within 1/2" (13 mm) of door face.

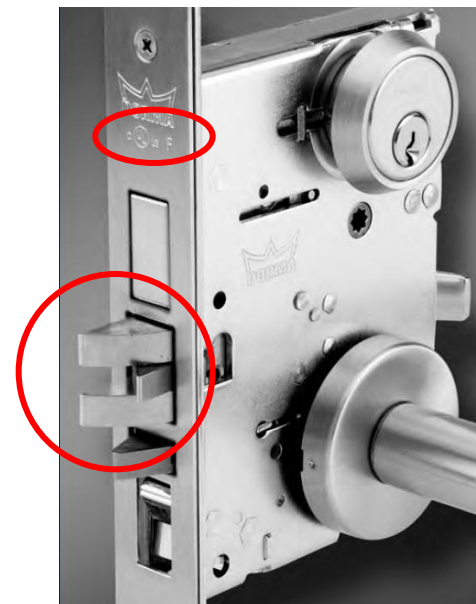

**Grade 1
Heavy-Duty
Mortise Locksets**

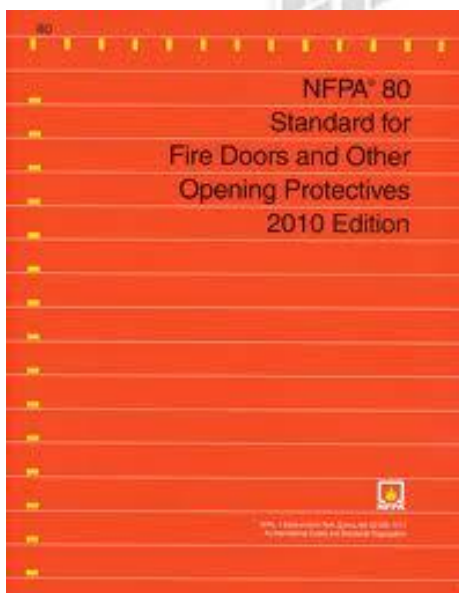

SDiB - Safety Design in Buildings

Access Control & Egress Planning.

Single external door



- SAFE
- SECURE**
- FIRE RATED

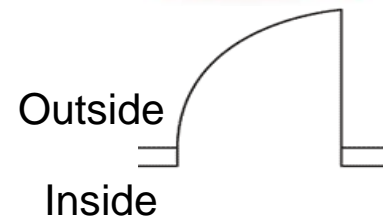

Office/Entry

M9053

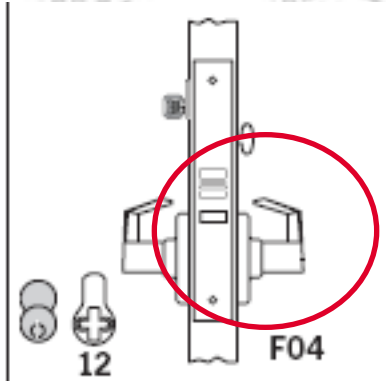

- Latch bolt operated by trim either side, except when outside trim locked by key outside or by inside turn.
- When outside trim locked, latch bolt retracted by key outside or by inside trim.
- Outside trim remains locked until inside turn rotated to unlocked position or unlocked by key.
- Auxiliary latch deadlocks latch bolt when door locked.

SDiB - Safety Design in Buildings

Access Control & Egress Planning.

■ Locks and Latches – PANIC BARS.

NFPA 101* (2003, 2006), NFPA 5000* (2003, 2006)

Required means of egress doors equipped with latches or locks serving:

- Assembly, Educational, or Day Care Occupancies with an occupant load of 100 people or more.
- High hazard contents areas with an occupant load in excess of 5.

Where panic hardware is required by code:

The International Building Code (2004 Supplement, 2006):

Each door in a means of egress equipped with latches or locks serving:

- Assembly or Educational Occupancies with an occupant load of 50 people or more.
- High Hazard occupancies (any occupant load).

NFPA 70 - The National Electric Code (2002, 2005) requires

certain electric rooms have doors that open in the direction of egress and are "equipped with panic bars, pressure plates, or other devices that are normally latched but open under simple pressure."

Technically, a hospital latch or paddle-type release would meet the requirement, but the fact that the words "panic bar" are used in the Code has prompted many code officials to require panic hardware. According to Article 110 of NFPA 70, personnel doors serving the following types of rooms must comply:

- Rooms housing large equipment - 600 Volts, nominal or more, or 1200 amperes or more.
- Rooms housing conductors and equipment used on circuits over 600 Volts, nominal.
- Transformer Vaults



SAFE



SECURE



FIRE RATED

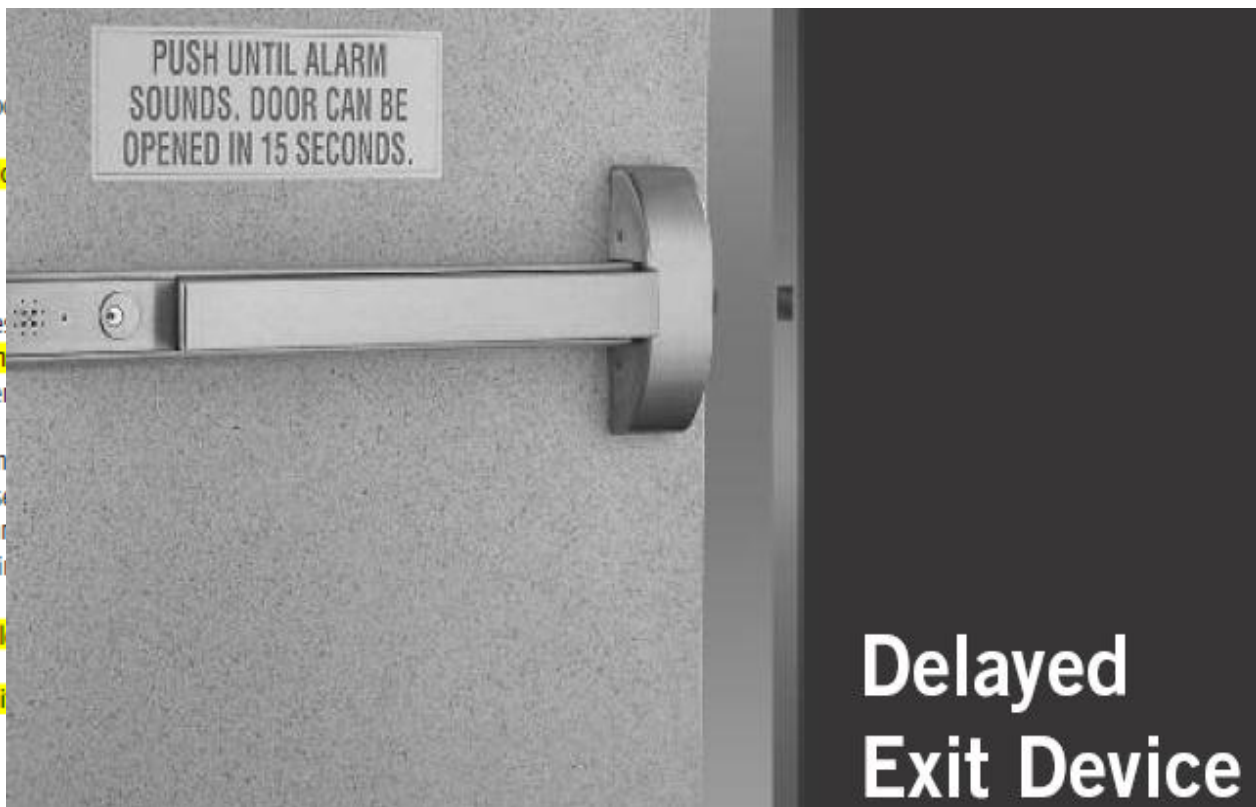

Delayed
Exit Device

Stairwell Reentry (NFPA 101[®]: 7.2.1.5.7, NFPA 5000[™]:11.2.1.5.8.1)

7.2.1.5.7* Every door assembly in a stair enclosure serving more than four stories, unless permitted by 7.2.1.5.7.2, shall meet one of the following conditions:

- (1) **Re-entry** from the stair enclosure to the interior of the building shall be provided.
- (2) An automatic release that is actuated with the initiation of the building fire alarm system shall be provided to unlock all stair enclosure door assemblies to allow re-entry.
- (3) Selected re-entry shall be provided in accordance with 7.2.1.5.7.1.

International Building Code[®] 2006

Stairway Doors (1008.1.8.7)

Interior stairway means of egress doors shall be openable from both sides without the use of a key or special knowledge or effort.

Exceptions:

- stairway discharge doors shall be openable from the egress side and shall only be locked from the opposite side
- section 403.12 refers to high-rise buildings (over 75 feet in height) and states that stair doors which are locked on the stair side must unlock simultaneously without unlatching upon a signal from the fire command system, and that a telephone or other 2-way communication device connected to a constantly attended station must be provided at every fifth floor if the stair doors are locked
- in stairways serving not more than 4 stories, doors may be locked on the stair side, as long as they are not locked on the egress side provided they are openable from the egress side and capable of being unlocked simultaneously without unlatching upon a signal from the fire command system

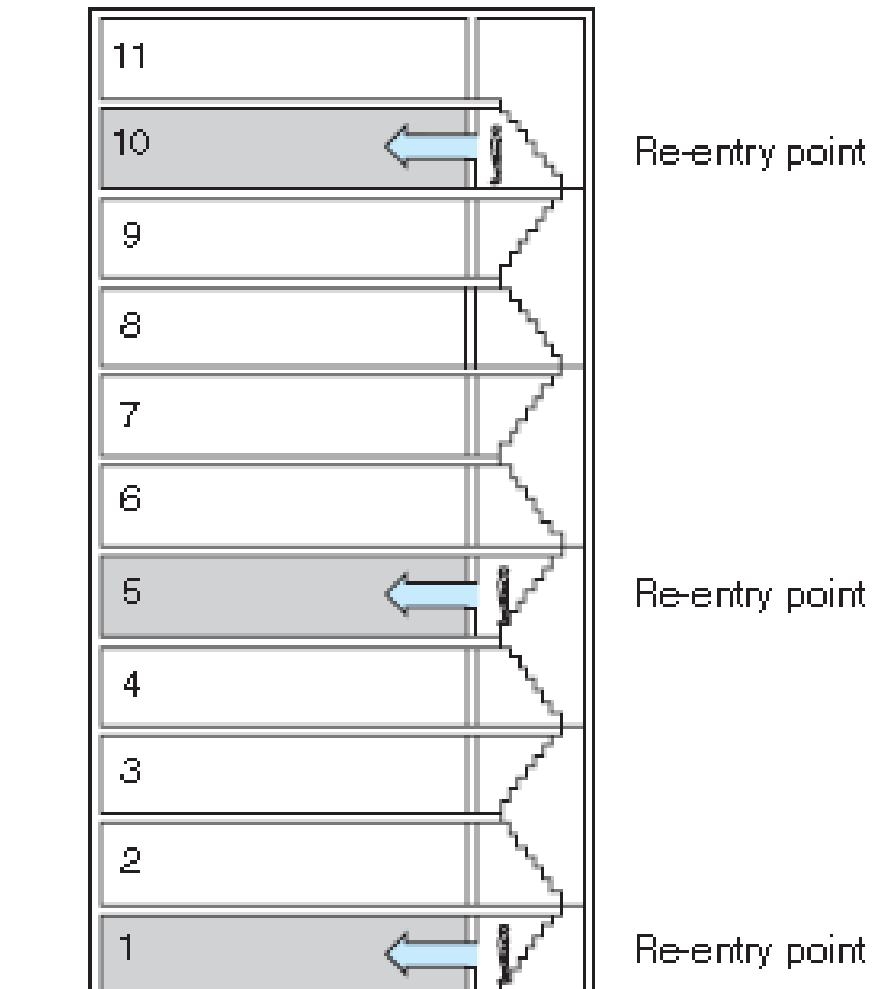

SDiB - Safety Design in Buildings

Access Control & Egress Planning.

Both **NFPA 101** and **NFPA 80** require Fire rated and Egress doors to be inspected annually by qualified professional and record kept by the building owner for authorities inspectors.

Inspections (5.2*)

5.2.1* **Fire door assemblies shall be inspected** and tested not less than annually, and a written record of the inspection shall be signed and kept for inspection by the AHJ.



SDiB - Safety Design in Buildings

Access Control & Egress Planning.

June 1883, Victoria Hall, Sunderland, Great Briton

183 children, aged between 3 and 14, were crushed to death in a stampede for the stage when free toys were offered. The disaster is the worst of its kind in British history.

Events

- At the end of the show an announcement was made that children with certain numbered tickets would be presented with a prize upon exit.
- At the same time entertainers began distributing gifts from the stage to the children in the stalls.
- Worried about missing out on the treats, many of the estimated 1,100 children in the gallery stampeded toward the staircase leading downstairs.
- **At the bottom of the staircase, the door had been opened inward and bolted in such a way as to leave a gap only wide enough for one child to pass at a time to ensure checking of tickets.**

Aftermath

- With the compressive asphyxia of 183 children between 3 and 14 years old, the disaster is the worst of its kind in British
- Newspaper reports at the time triggered a mood of national outrage and the resulting inquiry recommended that public venues be fitted with a minimum number of outward opening emergency exits, which led to the invention of 'push bar' emergency doors. This law still remains in full force as of today.
- No one was prosecuted for the disaster; the person responsible for bolting the door was never identified.

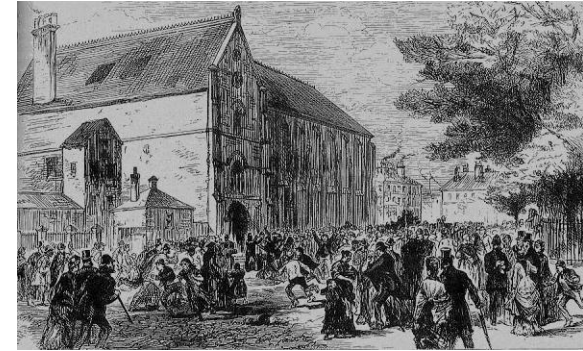

SDiB - Safety Design in Buildings

Access Control & Egress Planning.

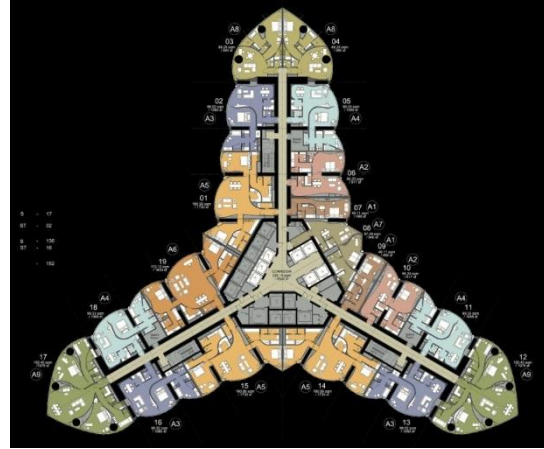

SDiB - Safety Design in Buildings

Access Control & Egress Planning.



SDiB - Safety Design in Buildings

Access Control & Egress Planning.

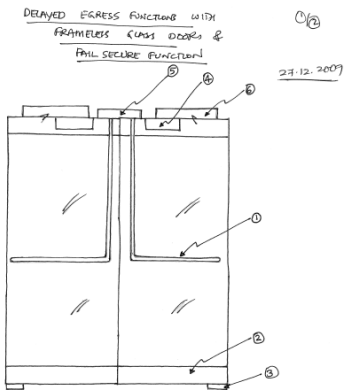
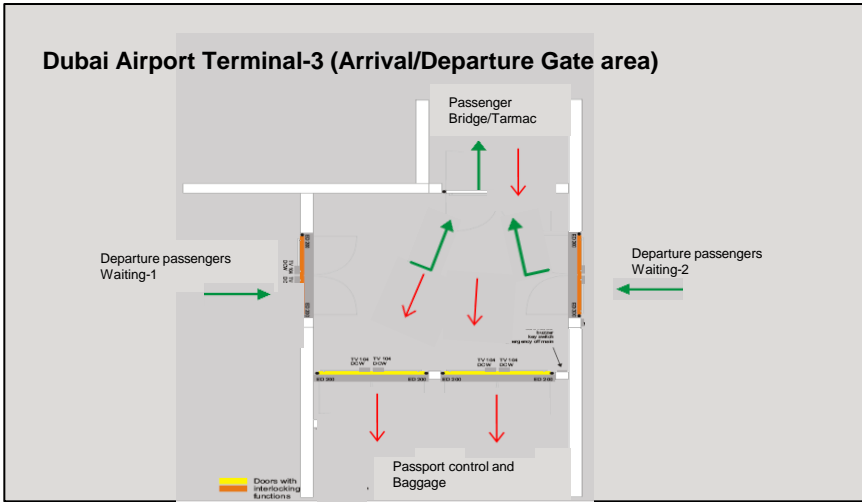

- ① - D6100 SERIES EXIT DEVICE FOR FRAMELESS DOORS
- ② - TOP & BOTTOM RAILS 100MM, STAINLESS STEEL
- ③ - FLOOR PIVOTS
- ④ - EMDE-1000 DELAYED EGRESS MNG. LOCKS (PUSH SIDE)
- ⑤ - FOLGER PIVOTS ELECTRICAL STRIKE (BOTH FAIL SAFE & FAIL SECURE AVAILABLE) - (PULL SIDE)
- ⑥ - FD200 SWING DOOR OPERATOR. (PUSH SIDE OR PULL SIDE AVAILABLE)



Access Control & Egress Planning

Thank You

—



Altaf A. Afridi, PMP, LEED AP, FDAI